

People Making Business

5.0

Cordoni elettrici di alimentazione

215

Power cord sets



5.1 Cordoni elettrici di alimentazione

216

Power cord sets



Grado di protezione /
IP protection degree



Spedizione / Shipment



Accessori / Accessories



Stock / Stock



Imballo pz / Packing pcs



Attenzione / Attention



Opzioni / Options



Contattaci / Contact us



CS-E2



Per gli articoli normalmente a stock spedizione in 48 h
For those items usually at stock shipment within 48 h



Per gli articoli non a stock lotto minimo 1000 pz
For those items not at stock MOQ 1000 pcs



Disponibile in altri colori su richiesta con lotto minimo
Available in other colours on request with MOQ



Contattaci per informazioni su versioni custom
Call us for information for custom version

EN 50075

2,5A - 250V AC -



Lato presa standard / Standard connector side

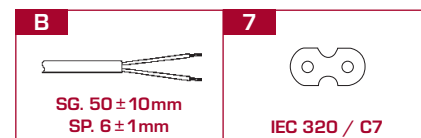

CODICE code	TIPO CAVO cable type	N° CONDUTTORI E SEZIONE section and n° of conductors	COLORE colour	LUNGHEZZA length	LATO SPINA plug side	LATO PRESA socket side		€
H3H275N015E2B	H03VVH2-F	2 x 0,75	●	1,5 mt	E2	B	stock	on request
H3H275N020E2B	H03VVH2-F	2 x 0,75	●	2 mt	E2	B	-	on request
H5H275N020E2B	H05VVH2-F	2 x 0,75	●	2 mt	E2	B	stock	on request
H5H275N025E2B	H05VVH2-F	2 x 0,75	●	2,5 mt	E2	B	-	on request
H3H275N015E27	H03VVH2-F	2 x 0,75	●	1,5 mt	E2	7	-	on request
H3H275N020E27	H03VVH2-F	2 x 0,75	●	2 mt	E2	7	stock	on request
H5H275N020E27	H05VVH2-F	2 x 0,75	●	2 mt	E2	7	-	on request
H5H275N025E27	H05VVH2-F	2 x 0,75	●	2,5 mt	E2	7	-	on request

CS-CH (E2 + Choke)



Lotto minimo 1000 pz
MOQ 1000 pcs



Disponibile in altri colori su richiesta
Available in other colours on request



Contattaci per informazioni su versioni custom
Call us for information for custom version

EN 50075

2,5A - 250V AC -



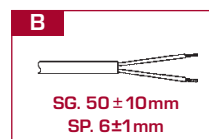

Lato presa standard / Standard connector side



CODICE code	TIPO CAVO cable type	N° CONDUTTORI E SEZIONE section and n° of conductors	COLORE colour	LUNGHEZZA length	LATO SPINA plug side	LATO PRESA socket side	€
H3H275N020CHB	H03VVH2-F	2 x 0,75	●	2 mt	CH	B	on request
H3H275N025CHB	H03VVH2-F	2 x 0,75	●	2,5 mt	CH	B	on request
H5H275N020CHB	H05VVH2-F	2 x 0,75	●	2 mt	CH	B	on request
H5H275N025CHB	H05VVH2-F	2 x 0,75	●	2,5 mt	CH	B	on request

CS-12



-  Lotto minimo 1000 pz
MOQ 1000 pcs
-  Disponibile in altri colori su richiesta
Available in other colours on request
-  Contattaci per informazioni su versioni custom
Call us for information for custom version

CEI 23-50

FOGLIO NORMATIVA / standard sheet S10

10A - 250V AC - 

Lato presa standard / Standard connector side

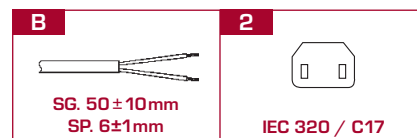

CODICE code	TIPO CAVO cable type	N° CONDUTTORI E SEZIONE section and n° of conductors	COLORE colour	LUNGHEZZA length	LATO SPINA plug side	LATO PRESA socket side	€
H5V275N020I2B	H05VV-F	2 x 0,75	●	2 mt	I2	B	on request
H5V275N025I2B	H05VV-F	2 x 0,75	●	2,5 mt	I2	B	on request
H5V210N020I2B	H05VV-F	2 x 1	●	2 mt	I2	B	on request
H5V210N025I2B	H05VV-F	2 x 1	●	2,5 mt	I2	B	on request
H5V275N020I22	H05VV-F	2 x 0,75	●	2 mt	I2	2	on request
H5V275N025I22	H05VV-F	2 x 0,75	●	2,5 mt	I2	2	on request
H5V210N020I22	H05VV-F	2 x 1	●	2 mt	I2	2	on request
H5V210N025I22	H05VV-F	2 x 1	●	2,5 mt	I2	2	on request

CS-10



-  Per gli articoli normalmente a stock spedizione in 48 h
For those items usually at stock shipment within 48 h
-  Per gli articoli non a stock lotto minimo 1000 pz
For those items not at stock MOQ 1000 pcs
-  Disponibile in altri colori su richiesta con lotto minimo
Available in other colours on request with MOQ
-  Contattaci per informazioni su versioni custom
Call us for information for custom version

CEI 23-50

FOGLIO NORMATIVA / standard sheet S11

10A - 250V AC - 

Lato presa standard / Standard connector side

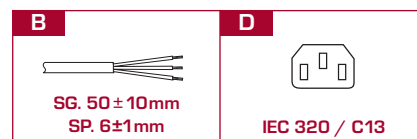

CODICE code	TIPO CAVO cable type	N° CONDUTTORI E SEZIONE section and n° of conductors	COLORE colour	LUNGHEZZA length	LATO SPINA plug side	LATO PRESA socket side		€
H5V375N015IOB	H05VV-F	3 x 0,75	●	1,5 mt	I0	B	-	on request
H5V375N020IOB	H05VV-F	3 x 0,75	●	2 mt	I0	B	stock	on request
H5V375N025IOB	H05VV-F	3 x 0,75	●	2,5 mt	I0	B	-	on request
H5V310N015IOB	H05VV-F	3 x 1	●	1,5 mt	I0	B	-	on request
H5V310N020IOB	H05VV-F	3 x 1	●	2 mt	I0	B	stock	on request
H5V310N025IOB	H05VV-F	3 x 1	●	2,5 mt	I0	B	-	on request
H5V375N015IOD	H05VV-F	3 x 0,75	●	1,5 mt	I0	D	stock	on request
H5V375N020IOD	H05VV-F	3 x 0,75	●	2 mt	I0	D	stock	on request
H5V375N025IOD	H05VV-F	3 x 0,75	●	2,5 mt	I0	D	stock	on request
H5V310N015IOD	H05VV-F	3 x 1	●	1,5 mt	I0	D	stock	on request
H5V310N020IOD	H05VV-F	3 x 1	●	2 mt	I0	D	stock	on request
H5V310N025IOD	H05VV-F	3 x 1	●	2,5 mt	I0	D	-	on request





CS-S2



Lotto minimo 1000 pz
MOQ 1000 pcs



Disponibile in altri colori su richiesta
Available in other colours on request



Contattaci per informazioni su versioni custom
Call us for information for custom version

CEI 23-50

IEC 60884-1

FOGLIO NORMATIVA / standard sheet S32

16A - 250V AC -



Lato presa standard / Standard connector side

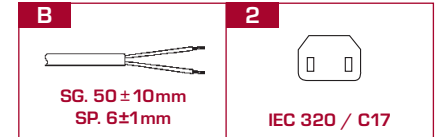

CODICE code	TIPO CAVO cable type	N° CONDUTTORI E SEZIONE section and n° of conductors	COLORE colour	LUNGHEZZA length	LATO SPINA plug side	LATO PRESA socket side	€
H5V275N020S2B	H05VV-F	2 x 0,75	●	2 mt	S2	B	on request
H5V275N025S2B	H05VV-F	2 x 0,75	●	2,5 mt	S2	B	on request
H5V210N020S2B	H05VV-F	2 x 1	●	2 mt	S2	B	on request
H5V210N025S2B	H05VV-F	2 x 1	●	2,5 mt	S2	B	on request
H5V215N020S2B	H05VV-F	2 x 1,5	●	2 mt	S2	B	on request
H5V215N025S2B	H05VV-F	2 x 1,5	●	2,5 mt	S2	B	on request
H5R275N020S2B	H05RR-F	2 x 0,75	●	2 mt	S2	B	on request
H5R275N025S2B	H05RR-F	2 x 0,75	●	2,5 mt	S2	B	on request
H5R210N020S2B	H05RR-F	2 x 1	●	2 mt	S2	B	on request
H5R210N025S2B	H05RR-F	2 x 1	●	2,5 mt	S2	B	on request
H5N275N020S2B	H05RN-F	2 x 0,75	●	2 mt	S2	B	on request
H5N275N025S2B	H05RN-F	2 x 0,75	●	2,5 mt	S2	B	on request
H5N210N020S2B	H05RN-F	2 x 1	●	2 mt	S2	B	on request
H5N210N025S2B	H05RN-F	2 x 1	●	2,5 mt	S2	B	on request
H7N210N020S2B	H07RN-F	2 x 1	●	2 mt	S2	B	on request
H7N210N025S2B	H07RN-F	2 x 1	●	2,5 mt	S2	B	on request
H7N215N020S2B	H07RN-F	2 x 1,5	●	2 mt	S2	B	on request
H7N215N025S2B	H07RN-F	2 x 1,5	●	2,5 mt	S2	B	on request
H5V275N020S22	H05VV-F	2 x 0,75	●	2 mt	S2	2	on request
H5V275N025S22	H05VV-F	2 x 0,75	●	2,5 mt	S2	2	on request
H5V210N020S22	H05VV-F	2 x 1	●	2 mt	S2	2	on request
H5V210N025S22	H05VV-F	2 x 1	●	2,5 mt	S2	2	on request

CS-W3



-  Lotto minimo 1000 pz
MOQ 1000 pcs
-  Disponibile in altri colori su richiesta
Available in other colours on request
-  Contattaci per informazioni su versioni custom
Call us for information for custom version

CEI 23-50
IEC 60884-1

FOGLIO NORMATIVA / standard sheet S31

16A - 250V AC -  

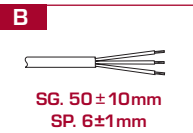

Lato presa standard / Standard connector side



CODICE code	TIPO CAVO cable type	N° CONDUTTORI E SEZIONE section and n° of conductors	COLORE colour	LUNGHEZZA length	LATO SPINA plug side	LATO PRESA socket side	€
H5N375N015W3B	H05RN-F	3 x 0,75	●	1,5 mt	W3	B	on request
H5N375N020W3B	H05RN-F	3 x 0,75	●	2 mt	W3	B	on request
H5N375N025W3B	H05RN-F	3 x 0,75	●	2,5 mt	W3	B	on request
H5N310N015W3B	H05RN-F	3 x 1	●	1,5 mt	W3	B	on request
H5N310N020W3B	H05RN-F	3 x 1	●	2 mt	W3	B	on request
H5N310N025W3B	H05RN-F	3 x 1	●	2,5 mt	W3	B	on request
H7N310N015W3B	H07RN-F	3 x 1	●	1,5 mt	W3	B	on request
H7N310N020W3B	H07RN-F	3 x 1	●	2 mt	W3	B	on request
H7N310N025W3B	H07RN-F	3 x 1	●	2,5 mt	W3	B	on request
H7N315N015W3B	H07RN-F	3 x 1,5	●	1,5 mt	W3	B	on request
H7N315N020W3B	H07RN-F	3 x 1,5	●	2 mt	W3	B	on request
H7N315N025W3B	H07RN-F	3 x 1,5	●	2,5 mt	W3	B	on request

CS-SW



-  Lotto minimo 1000 pz
MOQ 1000 pcs
-  Disponibile in altri colori su richiesta
Available in other colours on request
-  Contattaci per informazioni su versioni custom
Call us for information for custom version

SEV 1011
IEC 60884-1

FOGLIO NORMATIVA / standard sheet SNV 416534-2

10A - 250V AC - 

Lato presa standard / Standard connector side

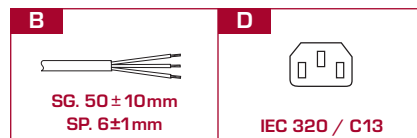

CODICE code	TIPO CAVO cable type	N° CONDUTTORI E SEZIONE section and n° of conductors	COLORE colour	LUNGHEZZA length	LATO SPINA plug side	LATO PRESA socket side	€
H5V375N020SWB	H05VV-F	3 x 0,75	●	2 mt	SW	B	on request
H5V375N025SWB	H05VV-F	3 x 0,75	●	2,5 mt	SW	B	on request
H5V310N020SWB	H05VV-F	3 x 1	●	2 mt	SW	B	on request
H5V310N025SWB	H05VV-F	3 x 1	●	2,5 mt	SW	B	on request
H5V375N020SWD	H05VV-F	3 x 0,75	●	2 mt	SW	D	on request
H5V375N025SWD	H05VV-F	3 x 0,75	●	2,5 mt	SW	D	on request
H5V310N020SWD	H05VV-F	3 x 1	●	2 mt	SW	D	on request
H5V310N025SWD	H05VV-F	3 x 1	●	2,5 mt	SW	D	on request
H5N375N020SWB	H05RN-F	3 x 0,75	●	2 mt	SW	B	on request
H5N375N025SWB	H05RN-F	3 x 0,75	●	2,5 mt	SW	B	on request
H5N310N020SWB	H05RN-F	3 x 1	●	2 mt	SW	B	on request
H5N310N025SWB	H05RN-F	3 x 1	●	2,5 mt	SW	B	on request





CS-SD



- Per gli articoli normalmente a stock spedizione in 48 h
For those items usually at stock shipment within 48 h
- Per gli articoli non a stock lotto minimo 1000 pz
For those items not at stock MOQ 1000 pcs
- Disponibile in altri colori su richiesta con lotto minimo
Available in other colours on request with MOQ
- Contattaci per informazioni su versioni custom
Call us for information for custom version

CEI 23-50

IEC 60884-1

FOGLIO NORMATIVA / standard sheet S31

16A - 250V AC -



Lato presa standard / Standard connector side

B SG. 50 ± 10mm SP. 6 ± 1mm	D IEC 320 / C13	H IEC 320 / C15 120 °C	D16 IEC 320 / C19
--	-------------------------------	--------------------------------------	---------------------------------

CODICE code	TIPO CAVO cable type	N° CONDUTTORI E SEZIONE section and n° of conductors	COLORE colour	LUNGHEZZA length	LATO SPINA plug side	LATO PRESA socket side		€
H5V375N015SDB	H05VV-F	3 x 0,75	●	1,5 mt	SD	B	-	on request
H5V375N020SDB	H05VV-F	3 x 0,75	●	2 mt	SD	B	-	on request
H5V375N025SDB	H05VV-F	3 x 0,75	●	2,5 mt	SD	B	-	on request
H5V310N015SDB	H05VV-F	3 x 1	●	1,5 mt	SD	B	stock	on request
H5V310N020SDB	H05VV-F	3 x 1	●	2 mt	SD	B	-	on request
H5V310N025SDB	H05VV-F	3 x 1	●	2,5 mt	SD	B	-	on request
H5V315N015SDB	H05VV-F	3 x 1,5	●	1,5 mt	SD	B	-	on request
H5V315N020SDB	H05VV-F	3 x 1,5	●	2 mt	SD	B	-	on request
H5V315N025SDB	H05VV-F	3 x 1,5	●	2,5 mt	SD	B	-	on request
H5V375N015SDD	H05VV-F	3 x 0,75	●	1,5 mt	SD	D	stock	on request
H5V375N020SDD	H05VV-F	3 x 0,75	●	2 mt	SD	D	stock	on request
H5V375N025SDD	H05VV-F	3 x 0,75	●	2,5 mt	SD	D	-	on request
H5V310N015SDD	H05VV-F	3 x 1	●	1,5 mt	SD	D	-	on request
H5V310N020SDD	H05VV-F	3 x 1	●	2 mt	SD	D	stock	on request
H5V310N025SDD	H05VV-F	3 x 1	●	2,5 mt	SD	D	stock	on request
H5V315N015SDD16	H05VV-F	3 x 1,5	●	1,5 mt	SD	D16	-	on request
H5V315N020SDD16	H05VV-F	3 x 1,5	●	2 mt	SD	D16	-	on request
H5V315N025SDD16	H05VV-F	3 x 1,5	●	2,5 mt	SD	D16	stock	on request
H5R375N020SDB	H05RR-F	3 x 0,75	●	2 mt	SD	B	-	on request
H5R375N025SDB	H05RR-F	3 x 0,75	●	2,5 mt	SD	B	-	on request
H5R310N020SDB	H05RR-F	3 x 1	●	2 mt	SD	B	-	on request
H5R310N025SDB	H05RR-F	3 x 1	●	2,5 mt	SD	B	-	on request
H5N375N020SDB	H05RN-F	3 x 0,75	●	2 mt	SD	B	-	on request
H5N375N025SDB	H05RN-F	3 x 0,75	●	2,5 mt	SD	B	-	on request
H5N310N020SDB	H05RN-F	3 x 1	●	2 mt	SD	B	-	on request
H5N310N025SDB	H05RN-F	3 x 1	●	2,5 mt	SD	B	-	on request
H7N310N015SDB	H07RN-F	3 x 1	●	1,5 mt	SD	B	-	on request
H7N310N020SDB	H07RN-F	3 x 1	●	2 mt	SD	B	stock	on request
H7N310N025SDB	H07RN-F	3 x 1	●	2,5 mt	SD	B	-	on request
H7N315N015SDB	H07RN-F	3 x 1,5	●	1,5 mt	SD	B	stock	on request
H7N315N020SDB	H07RN-F	3 x 1,5	●	2 mt	SD	B	-	on request
H7N315N025SDB	H07RN-F	3 x 1,5	●	2,5 mt	SD	B	-	on request



-  Per gli articoli normalmente a stock spedizione in 48 h
For those items usually at stock shipment within 48 h
-  Per gli articoli non a stock lotto minimo 1000 pz
For those items not at stock MOQ 1000 pcs
-  Disponibile in altri colori su richiesta con lotto minimo
Available in other colours on request with MOQ
-  Contattaci per informazioni su versioni custom
Call us for information for custom version



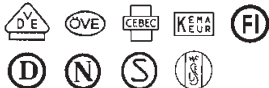

CEI 23-50
IEC 60884-1

FOGLIO NORMATIVA/standard sheet S31

16A - 250V AC -



Lato presa standard / Standard connector side



B	D	H	D16
			
SG. 50±10mm SP. 6±1mm	IEC 320 / C13	IEC 320 / C15 120 °C	IEC 320 / C19

CODICE code	TIPO CAVO cable type	N° CONDUTTORI E SEZIONE section and n° of conductors	COLORE colour	LUNGHEZZA length	LATO SPINA plug side	LATO PRESA socket side		€
H5V375N015SAB	H05VV-F	3 x 0,75	●	1,5 mt	SA	B	-	on request
H5V375N020SAB	H05VV-F	3 x 0,75	●	2 mt	SA	B	stock	on request
H5V375N025SAB	H05VV-F	3 x 0,75	●	2,5 mt	SA	B	-	on request
H5V310N015SAB	H05VV-F	3 x 1	●	1,5 mt	SA	B	-	on request
H5V310N020SAB	H05VV-F	3 x 1	●	2 mt	SA	B	-	on request
H5V310N025SAB	H05VV-F	3 x 1	●	2,5 mt	SA	B	stock	on request
H5V315N015SAB	H05VV-F	3 x 1,5	●	1,5 mt	SA	B	-	on request
H5V315N020SAB	H05VV-F	3 x 1,5	●	2 mt	SA	B	stock	on request
H5V315N025SAB	H05VV-F	3 x 1,5	●	2,5 mt	SA	B	stock	on request
H5V375N015SAD	H05VV-F	3 x 0,75	●	1,5 mt	SA	D	-	on request
H5V375N020SAD	H05VV-F	3 x 0,75	●	2 mt	SA	D	stock	on request
H5V375N025SAD	H05VV-F	3 x 0,75	●	2,5 mt	SA	D	-	on request
H5V310N015SAD	H05VV-F	3 x 1	●	1,5 mt	SA	D	-	on request
H5V310N020SAD	H05VV-F	3 x 1	●	2 mt	SA	D	stock	on request
H5V310N025SAD	H05VV-F	3 x 1	●	2,5 mt	SA	D	stock	on request
H5V315N015SAD16	H05VV-F	3 x 1,5	●	1,5 mt	SA	D16	-	on request
H5V315N020SAD16	H05VV-F	3 x 1,5	●	2 mt	SA	D16	-	on request
H5V315N025SAD16	H05VV-F	3 x 1,5	●	2,5 mt	SA	D16	-	on request
H5R375N020SAB	H05RR-F	3 x 0,75	●	2 mt	SA	B	-	on request
H5R375N025SAB	H05RR-F	3 x 0,75	●	2,5 mt	SA	B	-	on request
H5R310N020SAB	H05RR-F	3 x 1	●	2 mt	SA	B	-	on request
H5R310N025SAB	H05RR-F	3 x 1	●	2,5 mt	SA	B	-	on request
H5N375N020SAB	H05RN-F	3 x 0,75	●	2 mt	SA	B	-	on request
H5N375N025SAB	H05RN-F	3 x 0,75	●	2,5 mt	SA	B	-	on request
H5N310N020SAB	H05RN-F	3 x 1	●	2 mt	SA	B	-	on request
H5N310N025SAB	H05RN-F	3 x 1	●	2,5 mt	SA	B	-	on request
H7N310N015SAB	H07RN-F	3 x 1	●	1,5 mt	SA	B	-	on request
H7N310N020SAB	H07RN-F	3 x 1	●	2 mt	SA	B	-	on request
H7N310N025SAB	H07RN-F	3 x 1	●	2,5 mt	SA	B	-	on request
H7N315N015SAB	H07RN-F	3 x 1,5	●	1,5 mt	SA	B	-	on request
H7N315N020SAB	H07RN-F	3 x 1,5	●	2 mt	SA	B	-	on request
H7N315N025SAB	H07RN-F	3 x 1,5	●	2,5 mt	SA	B	-	on request



CS-GE_x





-  Lotto minimo 1000 pz
MOQ 1000 pcs
-  Disponibile in altri colori su richiesta
Available in other colours on request
-  Contattaci per informazioni su versioni custom
Call us for information for custom version

BS 1363A/95

3/5/10/13A - 250V AC - 

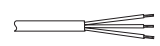
Lato presa standard / Standard connector side

B	D	7
 SG. 50 ± 10 mm SP. 6 ± 1 mm	 IEC 320 / C13	 IEC 320 / C7

CODICE code	TIPO CAVO cable type	N° CONDUTTORI E SEZIONE section and n° of conductors	COLORE colour	FUSIBILE fuse	LUNGHEZZA length	LATO SPINA plug side	LATO PRESA socket side	€
H3H275N015GE3B	H03VVH2-F	2 x 0,75	●	3A	1,5 mt	GE3	B	on request
H3H275N020GE3B	H03VVH2-F	2 x 0,75	●	3A	2 mt	GE3	B	on request
H3H275N025GE3B	H03VVH2-F	2 x 0,75	●	3A	2,5 mt	GE3	B	on request
H5V275N020GE1B	H05VV-F	2 x 0,75	●	13A	2 mt	GE1	B	on request
H5V275N025GE1B	H05VV-F	2 x 0,75	●	13A	2,5 mt	GE1	B	on request
H5V375N015GE1B	H05VV-F	3 x 0,75	●	13A	1,5 mt	GE1	B	on request
H5V375N020GE1B	H05VV-F	3 x 0,75	●	13A	2 mt	GE1	B	on request
H5V375N025GE1B	H05VV-F	3 x 0,75	●	13A	2,5 mt	GE1	B	on request
H5V310N015GE1B	H05VV-F	3 x 1	●	13A	1,5 mt	GE1	B	on request
H5V310N020GE1B	H05VV-F	3 x 1	●	13A	2 mt	GE1	B	on request
H5V310N025GE1B	H05VV-F	3 x 1	●	13A	2,5 mt	GE1	B	on request
H5V375N020GE1D	H05VV-F	3 x 0,75	●	13A	2 mt	GE1	D	on request
H5V375N025GE1D	H05VV-F	3 x 0,75	●	13A	2,5 mt	GE1	D	on request
H5V310N020GE1D	H05VV-F	3 x 1	●	13A	2 mt	GE1	D	on request
H5V310N025GE1D	H05VV-F	3 x 1	●	13A	2,5 mt	GE1	D	on request

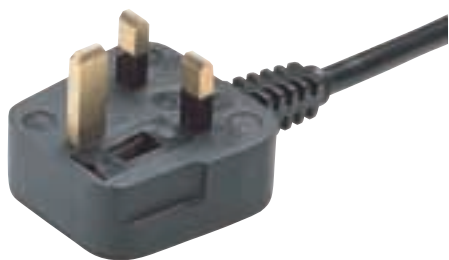

Per gli articoli normalmente a stock spedizione in 48 h
For those items usually at stock shipment within 48 h



Per gli articoli non a stock lotto minimo 1000 pz
For those items not at stock MOQ 1000 pcs



Disponibile in altri colori su richiesta con lotto minimo
Available in other colours on request with MOQ



Contattaci per informazioni su versioni custom
Call us for information for custom version

BS 1363A/95

3/5/10/13A - 250V AC -

Lato presa standard / Standard connector side

B	D	7
SG. 50 ± 10mm SP. 6 ± 1mm	IEC 320 / C13	IEC 320 / C7

CODICE code	TIPO CAVO cable type	N° CONDUTTORI E SEZIONE section and n° of conductors	COLORE colour	FUSIBILE fuse	LUNGHEZZA length	LATO SPINA plug side	LATO PRESA socket side		€
H3H275N015G3B	H03VVH2-F	2 x 0,75	●	3A	1,5 mt	G3	B	-	on request
H3H275N020G3B	H03VVH2-F	2 x 0,75	●	3A	2 mt	G3	B	-	on request
H3H275N025G3B	H03VVH2-F	2 x 0,75	●	3A	2,5 mt	G3	B	-	on request
H5V275N020G1B	H05VV-F	2 x 0,75	●	13A	2 mt	G1	B	-	on request
H5V275N025G1B	H05VV-F	2 x 0,75	●	13A	2,5 mt	G1	B	-	on request
H5V375N015G1B	H05VV-F	3 x 0,75	●	13A	1,5 mt	G1	B	-	on request
H5V375N020G1B	H05VV-F	3 x 0,75	●	13A	2 mt	G1	B	-	on request
H5V375N025G1B	H05VV-F	3 x 0,75	●	13A	2,5 mt	G1	B	-	on request
H5V310N015G1B	H05VV-F	3 x 1	●	13A	1,5 mt	G1	B	-	on request
H5V310N020G1B	H05VV-F	3 x 1	●	13A	2 mt	G1	B	-	on request
H5V310N025G1B	H05VV-F	3 x 1	●	13A	2,5 mt	G1	B	stock	on request
H5V315N015G1B	H05VV-F	3 x 1,5	●	13A	1,5 mt	G1	B	-	on request
H5V315N020G1B	H05VV-F	3 x 1,5	●	13A	2 mt	G1	B	-	on request
H5V315N025G1B	H05VV-F	3 x 1,5	●	13A	2,5 mt	G1	B	-	on request
H5V375N020G1D	H05VV-F	3 x 0,75	●	13A	2 mt	G1	D	-	on request
H5V375N025G1D	H05VV-F	3 x 0,75	●	13A	2,5 mt	G1	D	-	on request
H5V310N020G1D	H05VV-F	3 x 1	●	13A	2 mt	G1	D	-	on request
H5V310N025G1D	H05VV-F	3 x 1	●	13A	2,5 mt	G1	D	stock	on request
H5R275N020G1B	H05RR-F	2 x 0,75	●	13A	2 mt	G1	B	-	on request
H5R275N025G1B	H05RR-F	2 x 0,75	●	13A	2,5 mt	G1	B	-	on request
H5R210N020G1B	H05RR-F	2 x 1	●	13A	2 mt	G1	B	-	on request
H5R210N025G1B	H05RR-F	2 x 1	●	13A	2,5 mt	G1	B	-	on request
H5R375N020G1B	H05RR-F	3 x 0,75	●	13A	2 mt	G1	B	-	on request
H5R375N025G1B	H05RR-F	3 x 0,75	●	13A	2,5 mt	G1	B	-	on request
H5R310N020G1B	H05RR-F	3 x 1	●	13A	2 mt	G1	B	-	on request
H5R310N025G1B	H05RR-F	3 x 1	●	13A	2,5 mt	G1	B	-	on request
H5N275N020G1B	H05RN-F	2 x 0,75	●	13A	2 mt	G1	B	-	on request
H5N275N025G1B	H05RN-F	2 x 0,75	●	13A	2,5 mt	G1	B	-	on request
H5N210N020G1B	H05RN-F	2 x 1	●	13A	2 mt	G1	B	-	on request
H5N210N025G1B	H05RN-F	2 x 1	●	13A	2,5 mt	G1	B	-	on request
H5N375N020G1B	H05RN-F	3 x 0,75	●	13A	2 mt	G1	B	-	on request
H5N375N025G1B	H05RN-F	3 x 0,75	●	13A	2,5 mt	G1	B	-	on request
H5N310N020G1B	H05RN-F	3 x 1	●	13A	2 mt	G1	B	-	on request
H5N310N025G1B	H05RN-F	3 x 1	●	13A	2,5 mt	G1	B	-	on request





CS-DK



- Lotto minimo 1000 pz
MOQ 1000 pcs
- Disponibile in altri colori su richiesta
Available in other colours on request
- Contattaci per informazioni su versioni custom
Call us for information for custom version

SB 107-1 / SB 107-2-D1
10A - 250V AC -

Lato presa standard / Standard connector side

B	 SG. 50 ± 10mm SP. 6 ± 1mm	D	 IEC 320 / C13
----------	----------------------------------	----------	-------------------

CODICE code	TIPO CAVO cable type	N° CONDUTTORI E SEZIONE section and n° of conductors	COLORE colour	LUNGHEZZA length	LATO SPINA plug side	LATO PRESA socket side	€
H5V310N020DKB	H05VV-F	3 x 1	●	2 mt	DK	B	on request
H5V310N025DKB	H05VV-F	3 x 1	●	2,5 mt	DK	B	on request
H5V310N020DKD	H05VV-F	3 x 1	●	2 mt	DK	D	on request
H5V310N025DKD	H05VV-F	3 x 1	●	2,5 mt	DK	D	on request

CS-A3



- Per gli articoli normalmente a stock spedizione in 48 h
For those items usually at stock shipment within 48 h
- Per gli articoli non a stock lotto minimo 1000 pz
For those items not at stock MOQ 1000 pcs
- Disponibile in altri colori su richiesta con lotto minimo
Available in other colours on request with MOQ
- Contattaci per informazioni su versioni custom
Call us for information for custom version

AS 3112
10A - 250V AC -

Lato presa standard / Standard connector side

B	 SG. 50 ± 10mm SP. 6 ± 1mm	D	 IEC 320 / C13
----------	----------------------------------	----------	-------------------



CODICE code	TIPO CAVO cable type	N° CONDUTTORI E SEZIONE section and n° of conductors	COLORE colour	LUNGHEZZA length	LATO SPINA plug side	LATO PRESA socket side		€
H5V375N020A3B	H05VV-F	3 x 0,75	●	2 mt	A3	B	-	on request
H5V375N025A3B	H05VV-F	3 x 0,75	●	2,5 mt	A3	B	-	on request
H5V310N020A3B	H05VV-F	3 x 1	●	2 mt	A3	B	-	on request
H5V310N025A3B	H05VV-F	3 x 1	●	2,5 mt	A3	B	stock	on request
H5V315N020A3B	H05VV-F	3 x 1,5	●	2 mt	A3	B	-	on request
H5V315N025A3B	H05VV-F	3 x 1,5	●	2,5 mt	A3	B	-	on request
H5V375N020A3D	H05VV-F	3 x 0,75	●	2 mt	A3	D	-	on request
H5V375N025A3D	H05VV-F	3 x 0,75	●	2,5 mt	A3	D	-	on request
H5V310N020A3D	H05VV-F	3 x 1	●	2 mt	A3	D	-	on request
H5V310N025A3D	H05VV-F	3 x 1	●	2,5 mt	A3	D	stock	on request

CS-IS



SI 32/11/88

10A - 250V AC - 

-  Lotto minimo 1000 pz
MOQ 1000 pcs
-  Disponibile in altri colori su richiesta
Available in other colours on request
-  Contattaci per informazioni su versioni custom
Call us for information for custom version

Lato presa standard / Standard connector side

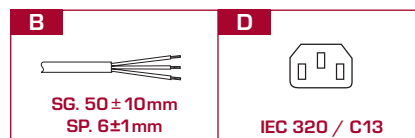



CODICE <i>code</i>	TIPO CAVO <i>cable type</i>	N° CONDUTTORI E SEZIONE <i>section and n° of conductors</i>	COLORE <i>colour</i>	LUNGHEZZA <i>length</i>	LATO SPINA <i>plug side</i>	LATO PRESA <i>socket side</i>	€
H5V375N015ISB	H05VV-F	3 x 0,75	●	1,5 mt	IS	B	on request
H5V375N020ISB	H05VV-F	3 x 0,75	●	2 mt	IS	B	on request
H5V375N025ISB	H05VV-F	3 x 0,75	●	2,5 mt	IS	B	on request
H5V310N015ISB	H05VV-F	3 x 1	●	1,5 mt	IS	B	on request
H5V310N020ISB	H05VV-F	3 x 1	●	2 mt	IS	B	on request
H5V310N025ISB	H05VV-F	3 x 1	●	2,5 mt	IS	B	on request
H5V315N015ISB	H05VV-F	3 x 1,5	●	1,5 mt	IS	B	on request
H5V315N020ISB	H05VV-F	3 x 1,5	●	2 mt	IS	B	on request
H5V315N025ISB	H05VV-F	3 x 1,5	●	2,5 mt	IS	B	on request
H5V375N015ISD	H05VV-F	3 x 0,75	●	1,5 mt	IS	D	on request
H5V375N020ISD	H05VV-F	3 x 0,75	●	2 mt	IS	D	on request
H5V375N025ISD	H05VV-F	3 x 0,75	●	2,5 mt	IS	D	on request
H5V310N015ISD	H05VV-F	3 x 1	●	1,5 mt	IS	D	on request
H5V310N020ISD	H05VV-F	3 x 1	●	2 mt	IS	D	on request
H5V310N025ISD	H05VV-F	3 x 1	●	2,5 mt	IS	D	on request

CS-AG



IRAM 2006/85, 2007/88, 2063/88

10A - 250V AC - 

-  Lotto minimo 1000 pz
MOQ 1000 pcs
-  Disponibile in altri colori su richiesta
Available in other colours on request
-  Contattaci per informazioni su versioni custom
Call us for information for custom version

Lato presa standard / Standard connector side

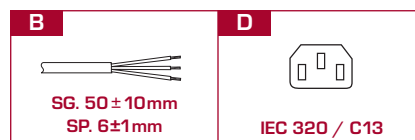

CODICE <i>code</i>	TIPO CAVO <i>cable type</i>	N° CONDUTTORI E SEZIONE <i>section and n° of conductors</i>	COLORE <i>colour</i>	LUNGHEZZA <i>length</i>	LATO SPINA <i>plug side</i>	LATO PRESA <i>socket side</i>	€
H5V375N015AGB	H05VV-F	3 x 0,75	●	1,5 mt	AG	B	on request
H5V375N020AGB	H05VV-F	3 x 0,75	●	2 mt	AG	B	on request
H5V375N025AGB	H05VV-F	3 x 0,75	●	2,5 mt	AG	B	on request
H5V310N015AGB	H05VV-F	3 x 1	●	1,5 mt	AG	B	on request
H5V310N020AGB	H05VV-F	3 x 1	●	2 mt	AG	B	on request
H5V310N025AGB	H05VV-F	3 x 1	●	2,5 mt	AG	B	on request
H5V315N015AGB	H05VV-F	3 x 1,5	●	1,5 mt	AG	B	on request
H5V315N020AGB	H05VV-F	3 x 1,5	●	2 mt	AG	B	on request
H5V315N025AGB	H05VV-F	3 x 1,5	●	2,5 mt	AG	B	on request
H5V375N015AGD	H05VV-F	3 x 0,75	●	1,5 mt	AG	D	on request
H5V375N020AGD	H05VV-F	3 x 0,75	●	2 mt	AG	D	on request
H5V375N025AGD	H05VV-F	3 x 0,75	●	2,5 mt	AG	D	on request
H5V310N015AGD	H05VV-F	3 x 1	●	1,5 mt	AG	D	on request
H5V310N020AGD	H05VV-F	3 x 1	●	2 mt	AG	D	on request
H5V310N025AGD	H05VV-F	3 x 1	●	2,5 mt	AG	D	on request





CS-AF



Lotto minimo 1000 pz
MOQ 1000 pcs



Disponibile in altri colori su richiesta
Available in other colours on request



Contattaci per informazioni su versioni custom
Call us for information for custom version

BS 546

5/10A - 250V AC -

Lato presa standard / Standard connector side

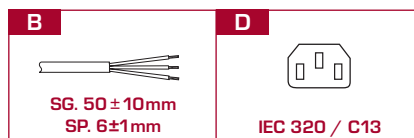

CODICE code	TIPO CAVO cable type	N° CONDUTTORI E SEZIONE section and n° of conductors	COLORE colour	LUNGHEZZA length	LATO SPINA plug side	LATO PRESA socket side	€
H5V375N020AFB	H05VV-F	3 x 0,75	●	2 mt	AF	B	on request
H5V375N025AFB	H05VV-F	3 x 0,75	●	2,5 mt	AF	B	on request
H5V310N020AFB	H05VV-F	3 x 1	●	2 mt	AF	B	on request
H5V310N025AFB	H05VV-F	3 x 1	●	2,5 mt	AF	B	on request
H5V315N020AFB	H05VV-F	3 x 1,5	●	2 mt	AF	B	on request
H5V315N025AFB	H05VV-F	3 x 1,5	●	2,5 mt	AF	B	on request
H5V375N020AFD	H05VV-F	3 x 0,75	●	2 mt	AF	D	on request
H5V375N025AFD	H05VV-F	3 x 0,75	●	2,5 mt	AF	D	on request
H5V310N020AFD	H05VV-F	3 x 1	●	2 mt	AF	D	on request
H5V310N025AFD	H05VV-F	3 x 1	●	2,5 mt	AF	D	on request

CS-CI



Lotto minimo 1000 pz
MOQ 1000 pcs



Disponibile in altri colori su richiesta
Available in other colours on request



Contattaci per informazioni su versioni custom
Call us for information for custom version

GB 2099.1 & 1002

10/16A - 250V AC -

Lato presa standard / Standard connector side

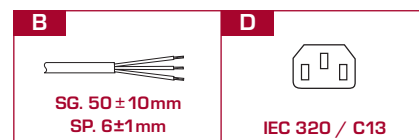

CODICE code	TIPO CAVO cable type	N° CONDUTTORI E SEZIONE section and n° of conductors	COLORE colour	LUNGHEZZA length	LATO SPINA plug side	LATO PRESA socket side	€
HRV375N020CIB	RVV	3 x 0,75	●	2 mt	CI	B	on request
HRV375N025CIB	RVV	3 x 0,75	●	2,5 mt	CI	B	on request
HRV310N020CIB	RVV	3 x 1	●	2 mt	CI	B	on request
HRV310N025CIB	RVV	3 x 1	●	2,5 mt	CI	B	on request
HRV375N015CID	RVV	3 x 0,75	●	1,5 mt	CI	D	on request
HRV375N020CID	RVV	3 x 0,75	●	2 mt	CI	D	on request
HRV310N020CID	RVV	3 x 1	●	2 mt	CI	D	on request
HRV310N025CID	RVV	3 x 1	●	2,5 mt	CI	D	on request



IEC 320 / C14

15A - 125V AC -

10A - 250V AC -



Per gli articoli normalmente a stock spedizione in 48 h
For those items usually at stock shipment within 48 h



Per gli articoli non a stock lotto minimo 1000 pz
For those items not at stock MOQ 1000 pcs





Disponibile in altri colori su richiesta con lotto minimo
Available in other colours on request with MOQ

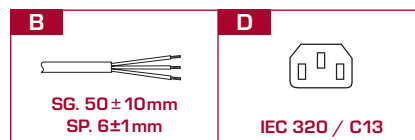

Contattaci per informazioni su versioni custom
Call us for information for custom version

Lato presa standard / Standard connector side



CODICE code	TIPO CAVO cable type	N° CONDUTTORI E SEZIONE section and n° of conductors	COLORE colour	TEMPERATURA temperature	LUNGHEZZA length	LATO SPINA plug side	LATO PRESA socket side		€
H5V375N015CDB	H05VV-F	3 x 0,75	●	-	1,5 mt	CD	B	-	on request
H5V375N020CDB	H05VV-F	3 x 0,75	●	-	2 mt	CD	B	-	on request
H5V375N025CDB	H05VV-F	3 x 0,75	●	-	2,5 mt	CD	B	-	on request
H5V310N015CDB	H05VV-F	3 x 1	●	-	1,5 mt	CD	B	-	on request
H5V310N020CDB	H05VV-F	3 x 1	●	-	2 mt	CD	B	-	on request
H5V310N025CDB	H05VV-F	3 x 1	●	-	2,5 mt	CD	B	-	on request
AVT18N015CDB060	SVT	3 x 18AWG	●	60°	1,5 mt	CD	B	-	on request
AVT18N020CDB060	SVT	3 x 18AWG	●	60°	2 mt	CD	B	-	on request
AVT18N025CDB060	SVT	3 x 18AWG	●	60°	2,5 mt	CD	B	-	on request
AJT18N015CDB105	SJT	3 x 18AWG	●	105°	1,5 mt	CD	B	-	on request
AJT18N020CDB105	SJT	3 x 18AWG	●	105°	2 mt	CD	B	-	on request
AJT18N025CDB105	SJT	3 x 18AWG	●	105°	2,5 mt	CD	B	-	on request
AJT16N015CDB105	SJT	3 x 16AWG	●	105°	1,5 mt	CD	B	-	on request
AJT16N020CDB105	SJT	3 x 16AWG	●	105°	2 mt	CD	B	-	on request
AJT16N025CDB105	SJT	3 x 16AWG	●	105°	2,5 mt	CD	B	-	on request
H5V375N015CDD	H05VV-F	3 x 0,75	●	-	1,5 mt	CD	D	stock	on request
H5V375N020CDD	H05VV-F	3 x 0,75	●	-	2 mt	CD	D	-	on request
H5V375N025CDD	H05VV-F	3 x 0,75	●	-	2,5 mt	CD	D	-	on request
H5V310N015CDD	H05VV-F	3 x 1	●	-	1,5 mt	CD	D	stock	on request
H5V310N020CDD	H05VV-F	3 x 1	●	-	2 mt	CD	D	-	on request
H5V310N025CDD	H05VV-F	3 x 1	●	-	2,5 mt	CD	D	stock	on request
AVT18N015CDD060	SVT	3 x 18AWG	●	60°	1,5 mt	CD	D	-	on request
AVT18N020CDD060	SVT	3 x 18AWG	●	60°	2 mt	CD	D	-	on request
AVT18N025CDD060	SVT	3 x 18AWG	●	60°	2,5 mt	CD	D	-	on request
AJT18N015CDD105	SJT	3 x 18AWG	●	105°	1,5 mt	CD	D	-	on request
AJT18N020CDD105	SJT	3 x 18AWG	●	105°	2 mt	CD	D	-	on request
AJT18N025CDD105	SJT	3 x 18AWG	●	105°	2,5 mt	CD	D	-	on request
AJT16N015CDD105	SJT	3 x 16AWG	●	105°	1,5 mt	CD	D	-	on request
AJT16N020CDD105	SJT	3 x 16AWG	●	105°	2 mt	CD	D	-	on request
AJT16N025CDD105	SJT	3 x 16AWG	●	105°	2,5 mt	CD	D	-	on request





CS-D2



Lotto minimo 1000 pz
MOQ 1000 pcs



Disponibile in altri colori su richiesta
Available in other colours on request



Contattaci per informazioni su versioni custom
Call us for information for custom version

IEC 320 / C20

20A - 125V AC -



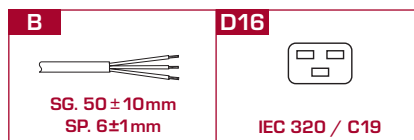

16A - 250V AC -

Lato presa standard / Standard connector side



CODICE code	TIPO CAVO cable type	N° CONDUTTORI E SEZIONE section and n° of conductors	COLORE colour	TEMPERATURA temperature	LUNGHEZZA length	LATO SPINA plug side	LATO PRESA socket side	€
H5V310N020D2B	H05VV-F	3 x 1	●	-	2 mt	IEC 20A	B	on request
H5V310N025D2B	H05VV-F	3 x 1	●	-	2,5 mt	IEC 20A	B	on request
H5V315N020D2B	H05VV-F	3 x 1,5	●	-	2 mt	IEC 20A	B	on request
H5V315N025D2B	H05VV-F	3 x 1,5	●	-	2,5 mt	IEC 20A	B	on request
SJT316N020D2B	SJT	3 x 16AWG	●	105°	2 mt	IEC 20A	B	on request
SJT316N025D2B	SJT	3 x 16AWG	●	105°	2,5 mt	IEC 20A	B	on request
H5V310N020D2D16	H05VV-F	3 x 1	●	-	2 mt	IEC 20A	D16	on request
H5V310N025D2D16	H05VV-F	3 x 1	●	-	2,5 mt	IEC 20A	D16	on request
H5V315N020D2D16	H05VV-F	3 x 1,5	●	-	2 mt	IEC 20A	D16	on request
H5V315N025D2D16	H05VV-F	3 x 1,5	●	-	2,5 mt	IEC 20A	D16	on request
SJT316N020D2D16	SJT	3 x 16AWG	●	105°	2 mt	IEC 20A	D16	on request
SJT316N025D2D16	SJT	3 x 16AWG	●	105°	2,5 mt	IEC 20A	D16	on request



-  Nella versione con lato presa 7 standard - Max 2,5A
Version with standard connector side 7 - Max 2,5A
-  Lotto minimo 1000 pz
MOQ 1000 pcs
-  Disponibile in altri colori su richiesta
Available in other colours on request
-  Contattaci per informazioni su versioni custom
Call us for information for custom version

NEMA 1-15P UL817 CSA 22.2 N. 21-95

10/13/15A - 125V AC -  

Lato presa standard / Standard connector side

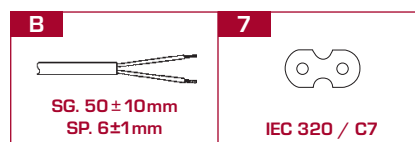

CODICE code	TIPO CAVO cable type	N° CONDUTTORI E SEZIONE section and n° of conductors	COLORE colour	TEMPERATURA temperature	LUNGHEZZA length	LATO SPINA plug side	LATO PRESA socket side	€
VERSIONE NON POLARIZZATA / NO POLARIZED VERSION								
AP218N0152NB105	SPT-2	2 x 18AWG	●	105°	1,5 mt	2N	B	on request
AP218N0202NB105	SPT-2	2 x 18AWG	●	105°	2 mt	2N	B	on request
AP218N0252NB105	SPT-2	2 x 18AWG	●	105°	2,5 mt	2N	B	on request
<hr/>								
AHP18N0152NB060	HPN	2 x 18AWG	●	60°	1,5 mt	2N	B	on request
AHP18N0202NB060	HPN	2 x 18AWG	●	60°	2 mt	2N	B	on request
AHP18N0252NB060	HPN	2 x 18AWG	●	60°	2,5 mt	2N	B	on request
<hr/>								
AHP16N0152NB060	HPN	2 x 16AWG	●	60°	1,5 mt	2N	B	on request
AHP16N0202NB060	HPN	2 x 16AWG	●	60°	2 mt	2N	B	on request
AHP16N0252NB060	HPN	2 x 16AWG	●	60°	2,5 mt	2N	B	on request
<hr/>								
AVT18N0152NB060	SVT	2 x 18AWG	●	60°	1,5 mt	2N	B	on request
AVT18N0202NB060	SVT	2 x 18AWG	●	60°	2 mt	2N	B	on request
AVT18N0252NB060	SVT	2 x 18AWG	●	60°	2,5 mt	2N	B	on request
<hr/>								
AVT16N0152NB060	SVT	2 x 16AWG	●	60°	1,5 mt	2N	B	on request
AVT16N0202NB060	SVT	2 x 16AWG	●	60°	2 mt	2N	B	on request
AVT16N0252NB060	SVT	2 x 16AWG	●	60°	2,5 mt	2N	B	on request
<hr/>								
AP218N0152N7060	SPT-2	2 x 18AWG	●	60°	1,5 mt	2N	7	on request
AP218N0202N7060	SPT-2	2 x 18AWG	●	60°	2 mt	2N	7	on request
AP218N0252N7060	SPT-2	2 x 18AWG	●	60°	2,5 mt	2N	7	on request
<hr/>								
VERSIONE POLARIZZATA / POLARIZED VERSION								
AP218N0152PB060	SPT-2	2 x 18AWG	●	60°	1,5 mt	2P	B	on request
AP218N0202PB060	SPT-2	2 x 18AWG	●	60°	2 mt	2P	B	on request
AP218N0252PB060	SPT-2	2 x 18AWG	●	60°	2,5 mt	2P	B	on request
<hr/>								
AHP18N0152PB060	HPN	2 x 18AWG	●	60°	1,5 mt	2P	B	on request
AHP18N0202PB060	HPN	2 x 18AWG	●	60°	2 mt	2P	B	on request
AHP18N0252PB060	HPN	2 x 18AWG	●	60°	2,5 mt	2P	B	on request
<hr/>								
AHP16N0152PB060	HPN	2 x 16AWG	●	60°	1,5 mt	2P	B	on request
AHP16N0202PB060	HPN	2 x 16AWG	●	60°	2 mt	2P	B	on request
AHP16N0252PB060	HPN	2 x 16AWG	●	60°	2,5 mt	2P	B	on request
<hr/>								
AVT18N0152PB060	SVT	2 x 18AWG	●	60°	1,5 mt	2P	B	on request
AVT18N0202PB060	SVT	2 x 18AWG	●	60°	2 mt	2P	B	on request
AVT18N0252PB060	SVT	2 x 18AWG	●	60°	2,5 mt	2P	B	on request
<hr/>								
AVT16N0152PB060	SVT	2 x 16AWG	●	60°	1,5 mt	2P	B	on request
AVT16N0202PB060	SVT	2 x 16AWG	●	60°	2 mt	2P	B	on request
AVT16N0252PB060	SVT	2 x 16AWG	●	60°	2,5 mt	2P	B	on request
<hr/>								
AP218N0152P7060	SPT-2	2 x 18AWG	●	60°	1,5 mt	2P	7	on request
AP218N0202P7060	SPT-2	2 x 18AWG	●	60°	2 mt	2P	7	on request
AP218N0252P7060	SPT-2	2 x 18AWG	●	60°	2,5 mt	2P	7	on request





Per gli articoli normalmente a stock spedizione in 48 h
For those items usually at stock shipment within 48 h

Per gli articoli non a stock lotto minimo 1000 pz
For those items not at stock MOQ 1000 pcs

Disponibile in altri colori su richiesta con lotto minimo
Available in other colours on request with MOQ

Contattaci per informazioni su versioni custom
Call us for information for custom version

NEMA 5-15P UL817 CSA 22.2 N 21-95

10/13/15A - 125V AC -

Lato presa standard / Standard connector side

B	D	D16
SG. 50 ± 10mm SP. 6 ± 1mm	IEC 320 / C13	IEC 320 / C19

CODICE code	TIPO CAVO cable type	N° CONDUTTORI E SEZIONE section and n° of conductors	COLORE colour	TEMPERATURA temperature	LUNGHEZZA length	LATO SPINA plug side	LATO PRESA socket side		€
AVT18N015UDB060	SVT	3 x 18AWG	●	60°	1,5 mt	UD	B	-	on request
AJT18N015UDB105	SJT	3 x 18AWG	●	105°	1,5 mt	UD	B	-	on request
AJT18N020UDB105	SJT	3 x 18AWG	●	105°	2 mt	UD	B	stock	on request
AJT16N015UDB105	SJT	3 x 16AWG	●	105°	1,5 mt	UD	B	-	on request
AJT14N015UDB105	SJT	3 x 14AWG	●	105°	1,5 mt	UD	B	-	on request
AJT14N020UDB105	SJT	3 x 14AWG	●	105°	2 mt	UD	B	-	on request
AJT14N025UDB105	SJT	3 x 14AWG	●	105°	2,5 mt	UD	B	stock	on request
AVT18N015UDD060	SVT	3 x 18AWG	●	60°	1,5 mt	UD	D	-	on request
AVT18N020UDD060	SVT	3 x 18AWG	●	60°	2 mt	UD	D	stock	on request
AJT18N015UDD105	SJT	3 x 18AWG	●	105°	1,5 mt	UD	D	-	on request
AJT18N020UDD105	SJT	3 x 18AWG	●	105°	2 mt	UD	D	stock	on request
AJT16N015UDD105	SJT	3 x 16AWG	●	105°	1,5 mt	UD	D	-	on request
AJT16N020UDD105	SJT	3 x 16AWG	●	105°	2 mt	UD	D	stock	on request
AJT16N020UDD16	SJT	3 x 16AWG	●	105°	2 mt	UD	D16	stock	on request
AJT14N020UDD16	SJT	3 x 14AWG	●	105°	2 mt	UD	D16	-	on request
ATO16N025UDB105	SJTO	3 x 16AWG	●	105°	2,5 mt	UD	B	stock	on request
ATO14N020UDB105	SJTO	3 x 14AWG	●	105°	2 mt	UD	B	stock	on request
ATO14N025UDB105	SJTO	3 x 14AWG	●	105°	2,5 mt	UD	B	stock	on request
ATO12N025UDB105	SJTO	3 x 12AWG	●	105°	2,5 mt	UD	B	-	on request
ATO16N020UDD105	SJTO	3 x 16AWG	●	105°	2 mt	UD	D	stock	on request
ATO16N025UDD105	SJTO	3 x 16AWG	●	105°	2,5 mt	UD	D	stock	on request
ATO14N025UDD16	SJTO	3 x 14AWG	●	105°	2,5 mt	UD	D16	-	on request

CS-NEMA 5-20



Per gli articoli normalmente a stock spedizione in 48 h
For those items usually at stock shipment within 48 h



Per gli articoli non a stock lotto minimo 1000 pz
For those items not at stock MOQ 1000 pcs



Disponibile in altri colori su richiesta con lotto minimo
Available in other colours on request with MOQ





Contattaci per informazioni su versioni custom
Call us for information for custom version

NEMA 5-20P UL817 CSA C22.2 N. 21-95

20A - 125V AC -  

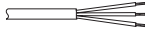
Lato presa standard / Standard connector side

B	D16
 SG. 50 ± 10mm SP. 6 ± 1mm	 IEC 320 / C19

CODICE code	TIPO CAVO cable type	N° CONDUTTORI E SEZIONE section and n° of conductors	COLORE colour	LUNGHEZZA length	LATO SPINA plug side	LATO PRESA socket side		€
AJT16N020UDB520	SJT	3 x 16AWG	●	2 mt	NEMA 5-20	B	-	on request
AJT16N025UDB520	SJT	3 x 16AWG	●	2,5 mt	NEMA 5-20	B	-	on request
AJT14N020UDB520	SJT	3 x 14AWG	●	2 mt	NEMA 5-20	B	-	on request
AJT14N025UDB520	SJT	3 x 14AWG	●	2,5 mt	NEMA 5-20	B	-	on request
ATO16N025UDB520	SJTO	3 x 16AWG	●	2,5 mt	NEMA 5-20	B	-	on request
ATO14N025UDB520	SJTO	3 x 14AWG	●	2,5 mt	NEMA 5-20	B	-	on request
ATO12N025UDB520	SJTO	3 x 12AWG	●	2,5 mt	NEMA 5-20	B	stock	on request
AJT16N020520D16	SJT	3 x 16AWG	●	2 mt	NEMA 5-20	D16	-	on request
AJT16N025520D16	SJT	3 x 16AWG	●	2,5 mt	NEMA 5-20	D16	-	on request
AJT14N020520D16	SJT	3 x 14AWG	●	2 mt	NEMA 5-20	D16	-	on request
AJT14N025520D16	SJT	3 x 14AWG	●	2,5 mt	NEMA 5-20	D16	-	on request
ATO16N025520D16	SJTO	3 x 16AWG	●	2,5 mt	NEMA 5-20	D16	-	on request
ATO14N025520D16	SJTO	3 x 14AWG	●	2,5 mt	NEMA 5-20	D16	-	on request



CS-NEMA 6-15

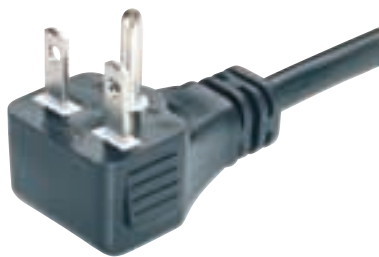

Lotto minimo 1000 pz
MOQ 1000 pcs



Disponibile in altri colori su richiesta
Available in other colours on request





Contattaci per informazioni su versioni custom
Call us for information for custom version

NEMA 6-15P UL817

15A - 250V AC -  

Lato presa standard / Standard connector side

B	D16
 SG. 50 ± 10mm SP. 6 ± 1mm	 IEC 320 / C19

CODICE code	TIPO CAVO cable type	N° CONDUTTORI E SEZIONE section and n° of conductors	COLORE colour	LUNGHEZZA length	LATO SPINA plug side	LATO PRESA socket side	€
AJT16N020UDB615	SJT	3 x 16AWG	●	2 mt	NEMA 6-15	B	on request
AJT16N025UDB615	SJT	3 x 16AWG	●	2,5 mt	NEMA 6-15	B	on request
AJT14N020UDB615	SJT	3 x 14AWG	●	2 mt	NEMA 6-15	B	on request
AJT14N025UDB615	SJT	3 x 14AWG	●	2,5 mt	NEMA 6-15	B	on request
ATO16N025UDB615	SJTO	3 x 16AWG	●	2,5 mt	NEMA 6-15	B	on request
ATO14N025UDB615	SJTO	3 x 14AWG	●	2,5 mt	NEMA 6-15	B	on request
AJT16N020615D16	SJT	3 x 16AWG	●	2 mt	NEMA 6-15	D16	on request
AJT16N025615D16	SJT	3 x 16AWG	●	2,5 mt	NEMA 6-15	D16	on request
AJT14N020615D16	SJT	3 x 14AWG	●	2 mt	NEMA 6-15	D16	on request
AJT14N025615D16	SJT	3 x 14AWG	●	2,5 mt	NEMA 6-15	D16	on request
ATO16N025615D16	SJTO	3 x 16AWG	●	2,5 mt	NEMA 6-15	D16	on request
ATO14N025615D16	SJTO	3 x 14AWG	●	2,5 mt	NEMA 6-15	D16	on request

CS-NEMA 6-20



NEMA 6-20P UL817

20A - 250V AC -  



Per gli articoli normalmente a stock spedizione in 48 h
For those items usually at stock shipment within 48 h



Per gli articoli non a stock lotto minimo 1000 pz
For those items not at stock MOQ 1000 pcs





Disponibile in altri colori su richiesta con lotto minimo
Available in other colours on request with MOQ

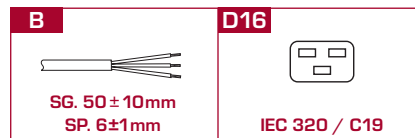

Contattaci per informazioni su versioni custom
Call us for information for custom version

Lato presa standard / Standard connector side



CODICE code	TIPO CAVO cable type	N° CONDUTTORI E SEZIONE section and n° of conductors	COLORE colour	LUNGHEZZA length	LATO SPINA plug side	LATO PRESA socket side		€
AJT16N020UDB620	SJT	3 x 16AWG	●	2 mt	NEMA 6-20	B	-	on request
AJT16N025UDB620	SJT	3 x 16AWG	●	2,5 mt	NEMA 6-20	B	-	on request
AJT14N020UDB620	SJT	3 x 14AWG	●	2 mt	NEMA 6-20	B	-	on request
AJT14N025UDB620	SJT	3 x 14AWG	●	2,5 mt	NEMA 6-20	B	-	on request
ATO16N025UDB620	SJTO	3 x 16AWG	●	2,5 mt	NEMA 6-20	B	-	on request
ATO14N025UDB620	SJTO	3 x 14AWG	●	2,5 mt	NEMA 6-20	B	-	on request
ATO12N025UDB620	SJTO	3 x 12AWG	●	2,5 mt	NEMA 6-20	B	-	on request
AJT16N020620D16	SJT	3 x 16AWG	●	2 mt	NEMA 6-20	D16	-	on request
AJT16N025620D16	SJT	3 x 16AWG	●	2,5 mt	NEMA 6-20	D16	-	on request
AJT14N020620D16	SJT	3 x 14AWG	●	2 mt	NEMA 6-20	D16	-	on request
AJT14N025620D16	SJT	3 x 14AWG	●	2,5 mt	NEMA 6-20	D16	-	on request
ATO16N025620D16	SJTO	3 x 16AWG	●	2,5 mt	NEMA 6-20	D16	-	on request
ATO14N025620D16	SJTO	3 x 14AWG	●	2,5 mt	NEMA 6-20	D16	-	on request

CS-J2



JIS C 8303

7-12-15A - 125V AC - 



Lotto minimo 1000 pz
MOQ 1000 pcs



Disponibile in altri colori su richiesta
Available in other colours on request



Contattaci per informazioni su versioni custom
Call us for information for custom version

Lato presa standard / Standard connector side

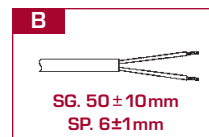



CODICE code	TIPO CAVO cable type	N° CONDUTTORI E SEZIONE section and n° of conductors	COLORE colour	LUNGHEZZA length	LATO SPINA plug side	LATO PRESA socket side	€
ACT75N025J2B	VCTF	2 x 0,75	●	2,5 mt	J2	B	on request
ACT25N025J2B	VCTF	2 x 1,25	●	2,5 mt	J2	B	on request
AHC75N025J2B	HVCTF	2 x 0,75	●	2,5 mt	J2	B	on request
AHC25N025J2B	HVCTF	2 x 1,25	●	2,5 mt	J2	B	on request



CS-J3





-  Lotto minimo 1000 pz
MOQ 1000 pcs
-  Disponibile in altri colori su richiesta
Available in other colours on request
-  Contattaci per informazioni su versioni custom
Call us for information for custom version

JIS C 8303

7/12/15A - 125V AC - 

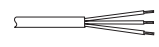

Lato presa standard / Standard connector side

 <p>B</p> <p>SG. 50 ± 10mm SP. 6 ± 1mm</p>	 <p>D</p> <p>IEC 320 / C13</p>
--	--

CODICE <i>code</i>	TIPO CAVO <i>cable type</i>	N° CONDUTTORI E SEZIONE <i>section and n° of conductors</i>	COLORE <i>colour</i>	LUNGHEZZA <i>length</i>	LATO SPINA <i>plug side</i>	LATO PRESA <i>socket side</i>	€
ACT75N015J3B	VCTF	3 x 0,75	●	1,5 mt	J3	B	on request
ACT75N020J3B	VCTF	3 x 0,75	●	2 mt	J3	B	on request
ACT75N025J3B	VCTF	3 x 0,75	●	2,5 mt	J3	B	on request
AHC75N015J3B	HVCTF	3 x 0,75	●	1,5 mt	J3	B	on request
AHC75N020J3B	HVCTF	3 x 0,75	●	2 mt	J3	B	on request
AHC75N025J3B	HVCTF	3 x 0,75	●	2,5 mt	J3	B	on request
ACT25N015J3B	VCTF	3 x 1,25	●	1,5 mt	J3	B	on request
ACT25N020J3B	VCTF	3 x 1,25	●	2 mt	J3	B	on request
ACT25N025J3B	VCTF	3 x 1,25	●	2,5 mt	J3	B	on request
AHC25N015J3B	HVCTF	3 x 1,25	●	1,5 mt	J3	B	on request
AHC25N020J3B	HVCTF	3 x 1,25	●	2 mt	J3	B	on request
AHC25N025J3B	HVCTF	3 x 1,25	●	2,5 mt	J3	B	on request
ACT20N015J3B	VCTF	3 x 2	●	1,5 mt	J3	B	on request
ACT20N020J3B	VCTF	3 x 2	●	2 mt	J3	B	on request
ACT20N025J3B	VCTF	3 x 2	●	2,5 mt	J3	B	on request
AHC20N015J3B	HVCTF	3 x 2	●	1,5 mt	J3	B	on request
AHC20N020J3B	HVCTF	3 x 2	●	2 mt	J3	B	on request
AHC20N025J3B	HVCTF	3 x 2	●	2,5 mt	J3	B	on request
ACT75N015J3D	VCTF	3 x 0,75	●	1,5 mt	J3	D	on request
ACT75N020J3D	VCTF	3 x 0,75	●	2 mt	J3	D	on request
ACT75N025J3D	VCTF	3 x 0,75	●	2,5 mt	J3	D	on request
AHC75N015J3D	HVCTF	3 x 0,75	●	1,5 mt	J3	D	on request
AHC75N020J3D	HVCTF	3 x 0,75	●	2 mt	J3	D	on request
AHC75N025J3D	HVCTF	3 x 0,75	●	2,5 mt	J3	D	on request
ACT25N015J3D	VCTF	3 x 1,25	●	1,5 mt	J3	D	on request
ACT25N020J3D	VCTF	3 x 1,25	●	2 mt	J3	D	on request
ACT25N025J3D	VCTF	3 x 1,25	●	2,5 mt	J3	D	on request
AHC25N015J3D	HVCTF	3 x 1,25	●	1,5 mt	J3	D	on request
AHC25N020J3D	HVCTF	3 x 1,25	●	2 mt	J3	D	on request
AHC25N025J3D	HVCTF	3 x 1,25	●	2,5 mt	J3	D	on request

CS-D



-  Lotto minimo 1000 pz
MOQ 1000 pcs
-  Disponibile in altri colori su richiesta
Available in other colours on request
-  Contattaci per informazioni su versioni custom
Call us for information for custom version

IEC 320 / C13

15A - 125V AC -  

10A - 250V AC -     
    



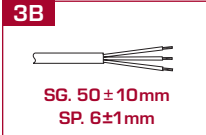









Lato standard / Standard side















CODICE code	TIPO CAVO cable type	N° CONDUTTORI E SEZIONE section and n° of conductors	COLORE colour	TEMPERATURA temperature	LUNGHEZZA length	LATO SPINA plug side	LATO PRESA socket side	€
H5V375N0153BD	H05VV-F	3 x 0,75	●	-	1,5 mt	B	D	on request
H5V375N0203BD	H05VV-F	3 x 0,75	●	-	2 mt	B	D	on request
H5V375N0253BD	H05VV-F	3 x 0,75	●	-	2,5 mt	B	D	on request
H5V310N0153BD	H05VV-F	3 x 1	●	-	1,5 mt	B	D	on request
H5V310N0203BD	H05VV-F	3 x 1	●	-	2 mt	B	D	on request
H5V310N0253BD	H05VV-F	3 x 1	●	-	2,5 mt	B	D	on request
AVT18N0153BD060	SVT	3 x 18AWG	●	60°	1,5 mt	B	D	on request
AVT18N0203BD060	SVT	3 x 18AWG	●	60°	2 mt	B	D	on request
AVT18N0253BD060	SVT	3 x 18AWG	●	60°	2,5 mt	B	D	on request
AJT18N0153BD105	SJT	3 x 18AWG	●	105°	1,5 mt	B	D	on request
AJT18N0203BD105	SJT	3 x 18AWG	●	105°	2 mt	B	D	on request
AJT18N0253BD105	SJT	3 x 18AWG	●	105°	2,5 mt	B	D	on request

OPZIONE LATO PRESA / socket side option

A

IEC 320 / C13
15A - 125V AC -  
10A - 250V AC -     
    

Disponibile nel cap. 11
Available in section 1.1

P

IEC 320 / C13
15A - 125V AC -  
10A - 250V AC -     
    

H

IEC 320 / C15 120°C
15A - 125V AC - 
10A - 250V AC - 



2

IEC 320 / C17
10A - 250V AC -





5

IEC 320 / C5
2,5/7/13A - 125/250V AC -  



D16

IEC 320 / C19
16A - 20A 125/250V AC -  

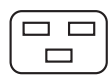

7

IEC 320 / C7
7A - 125V AC -  
2,5A - 250V AC - 



7P

IEC 320 / C7
7A - 125V AC -  
2,5A - 250V AC -





SEZIONI E PORTATE CAVI INTERNAZIONALI INTERNATIONAL CABLE SECTIONS AND RATING			
Numero Conduttori Number of Conductors	mm ²	Portata Rated 220/240V	Equivalente Equivalent to AWG
3	0,75	10 A	18
3	1,00	10 A	18
3	1,50	16 A	16
3	1,50	16 A	14
3	2,50	25 A	12

SEZIONI E PORTATE CAVI AMERICANI AMERICAN CABLE SECTIONS AND RATING			
Numero Conduttori Number of Conductors	AWG	Portata Rated 125V	Equivalente Equivalent to mm ²
3	18	10 A	0,816
3	16	13 A	1,326
3	14	18 A	2,091
3	12	25 A	3,315
3	10	30 A	5,370

Sigle di designazione dei cavi elettrici secondo il sistema di armonizzazione europea Cenelec
Denomination codes of main cords according to the european Cenelec harmonization document.

SIMBOLO SYMBOL	RIFERIMENTO ALLE NORME	SPECIFICATIONS REFERENCE
H A	1 Cavo conforme a norme armonizzate. Cavo di tipo nazionale riconosciuto.	Cable according to harmonized specification. Recognized national type of cable.
03 05 07	TENSIONE NOMINALE U ₀ /U 2 U ₀ /U = 300/300V U ₀ /U = 300/500V U ₀ /U = 450/750V	RATED VOLTAGE U ₀ /U U ₀ /U = 300/300V U ₀ /U = 300/500V U ₀ /U = 450/750V
V R	MATERIALI ISOLANTI 3 Polivinilcloruro comune (PVC) Gomma naturale	INSULATION MATERIALS Ordinary polyvinyl-chloride Natural rubber
V R N T	MATERIALI PER GUAINE 4 Polivinilcloruro comune (PVC) Gomma naturale Policloroprene (neoprene) Treccia tessile	SHEATH MATERIALS Ordinary polyvinyl-chloride Natural rubber Polychloroprene (neoprene) Textile braid
H H2	FORMA E COSTRUZIONI SPECIALI 5 Costruzione piatta di cavi divisibili Costruzione piatta di cavi non divisibili	SPECIAL CONTRUCTIONS AND SHAPES Flat construction of divisible cables Flat construction of non divisible cables
F H Y	TIPO DI CONDUTTORE 6 Conduttore flessibile Conduttore flessibilissimo Conduttore di similrame	TYPE OF CONDUCTOR Flexible conductor High flexible conductor Tinsel conductor
	7 NUMERO DELLE ANIME	NUMBER OF CORES
G X	SIMBOLO DI MOLTIPLICAZIONE 8 Con filo giallo/verde Senza filo giallo/verde	MULTIPLYING SYMBOL With green/yellow wire Without green/yellow wire
	9 SEZIONE NOMINALE CONDUTTORE espressa in mm ²	NOMINAL CROSS SECTION CONDUCTOR mm ²

DESIGNAZIONE CAVI UL
UL CORD TYPE DESIGNATION



XT	Christmas Tree Thermoplastic	SJOO	SJO with Oil-Resistant Insulation
TPT	Tinsel Parallel Thermoplastic	SJT	Service Junior Thermoplastic
TS	Tinsel Service	SJTO	SJT with Oil-Resistant Jacket
TST	Tinsel Service Thermoplastic	SJTOO	SJTO with Oil-Resistant Insulation
SPT-1	Service Parallel Thermoplastic-1/64" Insulation	SJE	Service Junior Elastomer
SPT-2	Service Parallel Thermoplastic-2/64" Insulation	SJEO	SJE with Oil-Resistant Jacket
SPT-3	Service Parallel Thermoplastic-3/64" Insulation	SJEOO	SJEO with Oil-Resistant Insulation
SPE-1	Service Parallel Elastomer-1/64" Insulation	S	Service
SPE-2	Service Parallel Elastomer-2/64" Insulation	SO	Service with Oil-Resistant Jacket
SPE-3	Service Parallel Elastomer-3/64" Insulation	SOO	SO with Oil-Resistant Insulation
SV	Service Vacuum	ST	Service Thermoplastic
SVO	Service Vacuum Oil-Resistant Jacket	STO	ST with Oil-Resistant Jacket
SVOO	SVO with Oil-Resistant Insulation	STOO	STO with Oil-Resistant Insulation
SVT	Service Vacuum Thermoplastic	SE	Service Elastomer
SVTO	SVT with Oil-Resistant Jacket	SEO	SE with Oil-Resistant Jacket
SVTOO	SVTO with Oil-Resistant Insulation	SEOO	SEO with Oil-Resistant Insulation
SVE	Service Vacuum Elastomer	HPN	Heater Service Neoprene
SVEO	SVE with Oil-Resistant Jacket	HSJ	Heater Service Junior
SVEOO	SVEO with Oil-Resistant Insulation	HSJO	HSJ with Oil-Resistant Jacket
SJ	Service Junior	HS	Heater Service
SJO	SJ with Oil-Resistant Jacket	HSO	HS with Oil-Resistant Jacket

CATEGORIA E COTRUZIONI CAVI UL
UL CORD CONSTRUCTION AND RATING

Cord Type <i>Cord Type</i>	AWG Size Range <i>Size Range</i>	No. of Cond. <i>No. of Cond.</i>	Conductor Insulation <i>Conductor Insulation</i>	Jacket <i>Jacket</i>	Temp. Rating <i>Temp. Rating</i>		Voltage <i>Voltage</i>
					Std./Std.	Altro/Other	
TPT	27 (Tinsel)	2	.030 Plastic		60		250
SP-1	18	2 or 3	.030 Rubber		60		300
SPT-1	18	2 or 3	.030 Plastic		60	75, 90, 105	300
SP-2	18-16	2 or 3	.045 Rubber		60		300
SPT-2	18-16	2 or 3	.045 Plastic		60	75, 90, 105	300
SP-3	18-12	2 or 3	.060 Rubber		60		300
SPT-3	18-10	2 or 3	.060 Plastic		60	75, 90, 105	300
TS	27 (Tinsel)	2	.015 Rubber	.031 Rubber	60		125
TST	27 (Tinsel)	2	.015 Plastic	.031 Plastic	60		125
SV	18	2 or 3	.015 Rubber	.030 Rubber	60	75, 90	300
SVE	18-17	2 or 3	.015 Elastomer	.030 Elastomer	105		300
SVEO	18-17	2 or 3	.015 Elastomer	.030 Elastomer	105		300
SVO	18	2 or 3	.015 Rubber	.030 Neoprene	60	75, 90	300
SVT	18-17	2 or 3	.015 Plastic	.030 Plastic	60	75, 90, 105	300
SVTO	18-17	2 or 3	.015 Plastic	.030 Plastic	60	75, 90, 105	300
SJ	18-10	2, 3, 4	.030 Rubber	.030 Rubber	60	75, 90	300
SJE	18-10	2, 3, 4, 5	.030 Elastomer	.030 Elastomer	105		300
SJEO	18-10	2, 3, 4, 5	.030 Elastomer	.030 Elastomer	105		300
SJO	18-10	2, 3, 4	.030 Rubber	.030 Neoprene	60	75, 90, 105	300
SJT	18-10	2, 3, 4	.030 Plastic	.030 Plastic	60	75, 90, 105	300
SJTO	18-10	2, 3, 4	.030 Plastic	.030 Plastic	60	75, 90, 105	300
S	18-2	2 or more	.030 Rubber	.060 Rubber	60	75, 90	600
SE	18-2	2 or more	.030 Elastomer	.060 Elastomer	105		600
SEO	18-2	2 or more	.030 Elastomer	.060 Elastomer	105		600
SO	18-2	2 or more	.030 Rubber	.060 Neoprene	60	75, 90	600
ST	18-2	2 or more	.030 Plastic	.060 Plastic	60	75, 90, 105	600
STO	18-2	2 or more	.030 Plastic	.060 Plastic	60	75, 90, 105	600
HPN	18-12	2 or 3	.045 Neoprene		90	105	300
HSJ	18-12	2, 3, 4	.030 Neoprene	.030 Rubber	90		300
HSJO	18-12	2, 3, 4	.030 Neoprene	.030 Neoprene	90		300
HS	14-12	2, 3, 4	.045 Neoprene	.060 Rubber	90		300
HSO	14-12	2, 3, 4	.045 Neoprene	.060 Neoprene	90		300



5.1 Cordonni elettrici di alimentazione

Power cord sets

A



Europe
CEE 7

B



CEE 7/16
Europe

C



Australia

D



United Kingdom

E



Denmark

F



France / Belgium

G



India & South Africa















H



Israele

Tipo Type	Paese Country	Tensione Voltage	Freq./Hz	Riferimento Pattern	Paese Country	Tensione Voltage	Freq./Hz	Riferimento Pattern
A	Afghanistan	220	50	G	Ecuador	120	60	B, K, N
	Algeria	127/200	50	B, G	Equatorial Guinea	220	50	B
	American Samoa	120/240	60	A, C, K., N	Estonia	220	50	A, B
	Angola	220	50	B	Ethiopia	220	50	A, B, F, G, I
	Anguilla (U.K.)	240	50	D	Fiji	240	50	C
	Antigua	230	60	K, D, N	Finland	220	50	A, B
	Argentina	220	50	B, C	France	220	50	B, F
	Aruba	115/127	60	A, B, G, K., N	French Guiana	220	50	B, F
	Australia	240	50	C, P	Gabon	220	50	B, F
	Austria	220	50	A, B	Gambia	220	50	D
	Azores (Portugal)	220	50	B, G	Germany	220	50	A, B
	Bahamas	120	60	K, N	Ghana	220	50	B, D, G
	Bahrain	220	50	D, G	Gibraltar	240	50	B, D
	Bangladesh	220	50	B, C	Greece	220	50	A, B
Barbados	115	50	K, N	Greenland (Dan.)	220	50	B, E	
Belgium	220	50	B, F	Grenada	230	50	B, D, G	
Belize (Br. Hond.)	110	60	K, N	Guadaloupe	220	50	B, F	
Benin	220	50	G	Guam	110-120	60	K, N	
Bermuda	120	60	C, D, K, N	Guatemala	120	60	K, N	
Bolivia	110-115/220	50	A, B, K, N	Guinea	220	50	B, F	
Bosnia-Herzegovina	220	50	A, B	Guinea-Bjissau	220	50	A, B	
Botswana	220	50	D, G	Guyana	110	50-60	B, D, G, K, N	
Brazil	110-220	60	B, K, N	Haiti	110-120	50-60	K, N	
Bulgaria	220	50	A, B	Honduras	110	60	K, N	
Burkina Faso	220	50	B	Hong Kong	200	50	D, G	
Burma (now Myanmar)	230	50	D, G	Hungary	220	50	A	
Burundi	220	50	A, B, F	Iceland	220	50	A, B	
Cambodia	120/220	50	B	India	220-250	50	B, G	
Cameroon	220-230	50	B, F	Indonesia	220	50	A, B	
Canada	120	60	K, N	Iran	220	50	A, B	
Canary Islands (Spain)	220	50	B, F	Iraq	220	50	B, D, G	
Cape Verde, Rep. of	220	50	A, B	Ireland, Rep. of (S.)	220	50	A, D	
Cayman Islands	120	60	K, N	Isle of Man	240	50	B, D	
Central African Rep.	220	50	B	Israel	230	50	A, H	
Chad	220	50	A, F, G	Italy	220	50	B, I	
Channel Islands	240	50	B, D	Ivory Coast	220	50	B	
Chile	220	50	B, i	Jamaica	110	50	K, N	
China, People's Rep. of	220	50	B, C	Japan	100	50 & 60	J, M	
Christmas Is. (Austral.)	240	50	C	Jordan	220	50	A, B, D	
Cocos Is. (Austral.)	240	50	C	Kenya	240	50	D, G	
Colombia	110-220	60	B, N	Korea, S.	220	60	A, N, K	
Congo, Rep. of	220	50	B	Kuwait	240	50	B, D, G	
Cook Is. (N.Z.)	240	50	C	Laos	220	50	B, K, N	
Costa Rica	120	60	K, N	Latvia	220	50	A, B	
Curacao Is.	110/220	60	A, K, P	Lebanon	110-220	50	B	
Cyprus	240	50	D	Lesotho	240	50	B, G	
Czech, Rep.	220	50	F, B	Liberia	120	60	D, N	
Denmark	220	50	B, E	Libya	127-230	50	G, I	
Djibouti, Rep. of	220	50	B, F	Liechtenstein	220	50	L	
Dominica	230	50	D	Lithuania	220	50	A, B	
Dominican Rep.	110	60	K, N	Luxembourg	220	50	A, B	
Egypt	220	50	B					
El Salvador	115	60	K, N					
England	240	50	D, G					



Paese Country	Tensione Voltage	Freq./Hz	Riferimento Pattern	Paese Country	Tensione Voltage	Freq./Hz	Riferimento Pattern	Tipo Type
Macao	220	50	B, G	Slovakia, Rep.	220	50	F, B	  Italy
Madagascar	220	50	B, F	Somalia	110/220	50	B, F	
Madeira (Portugal)	220	50	B, G	South Africa	220-250	50	G	  Japan
Majorca	220	50	A, B	Spain	220	50	B, F	
Malawi	230	50	D	Sri Lanka	230	50	G	
Malaysia	240	50	D	St. Pierre & Maquelin (Fr.)	115	60	K, N	
Maldives	230	50	G	St. Kitts & Nevis	230	60	D, G	
Mali, Rep. of	220	50	B, F	St. Lucia	240	50	D	
Malta	240	50	D	St. Vincent	230	50	D	
Martinique	220	50	B, F	Sudan	240	50	A, B, D	
Mauritania	220	50	B	Surinam	115	60	A, B	
Mauritius	230	50	B, D, G	Svalbard (Norway)	220	50	A, B	
Mexico	127	60	K, N	Swaziland	230	50	G	  North America (Nema 5-15)
Monaco	220	50	B, F	Sweden	220	50	A, B	
Mongolia	220	50	B	Switzerland	220	50	B, L	  Switzerland
Montseurat	230	60	D, K, N	Syria	220	50	B	
Mozambique	220	50	A, B	Tahiti	220	50	F	  Japan (polarizzata / polarized)
Morocco	220	50	A, B, F, G	Taiwan	110	60	K, N	
Namibia (W. S. Africa)	220-250	50	G	Tanzania	230	50	D, G	
Nepal	220	50	G	Thailand	220	50	B, K, N	
Netherlands	230	50	A, B	Togo	220	50	B, F	
Neth. Antilles	120-127/220	50/60	A, B, K, N	Tonga	115	60	C, G	
New Caledonia	220	50	B, F	Trinidad & Tobago	115/230	60	D, G, K, N	
New Zealand	230	50	C	Tunisia	220	50	B	
Nicaragua	120	60	K, N	Turkey	220	50	A, B	
Niger	220	50	B	Uganda	240	50	G	
Nigeria	230	50	D, G	United Arab Emir.	220	50	D, G	  Faccia piatta/ Flate blade (non polarizzata/ not polarized)
Norfolk Is. (Aust.)	240	50	C	United Kingdom & Ire.	240	50	D, G	
No. Mariana Is. (U.S.)	115	60	K, N	United States	120	60	K	
No. Ireland	220	50	D	Uruguay	220	50	B, C	
Norway	220	50	A, B	U.S.S.R.	220	50	A, B	
Okinawa	100-120	60	N	Venezuela	120	60	K, N	
Oman	240	50	D, G	Vietnam	120/220	50	B, F, K, N	
Pakistan	230	50	B, G	Virgin Islands	120	60	K, N	
Panama	110-120	60	K, N	Wales	220	50	D	
Papua New Guinea	240	50	C, P	Yemen	220	50	B, D, G	
Paraguay	220	50	B	(Yugoslavia)	220	50	A, B	
Perù	110/220	50/60	K, N	Zaire, Rep. of	220	50	F	
Philippines	115	60	B, K, N	Zanbia	220	50	D	  Australia Bipolare / 2 pole
Pitcarin Is. (U.K.)	240	50	G	Zimbabwe	220	50	D, G	
Poland	220	50	A, B					
Portugal	220	50	A, B, G					
Puerto Rico	120	60	K, N					
Qatar	240	50	D, G					
Romania	220	50	A, B					
Russia	220	50	A, B					
Rwanda	220	50	B					
Saudi Arabia	127/220	50/60	A, F, K, N					
Scotland	220	50	D					
Senegal	220	50	F					
Seychelles	240	50	D, G					
Sierra Leone	230	50	D, G					
Singapore	230	50	B, D, G					



Gioco di squadra

Teamwork